

TOP VIEW

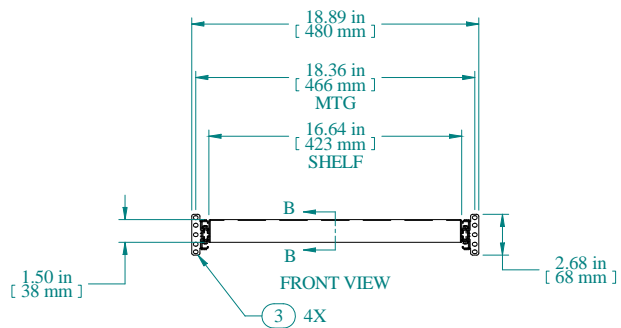

FRONT VIEW

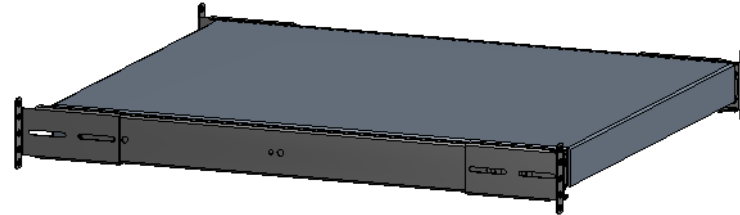
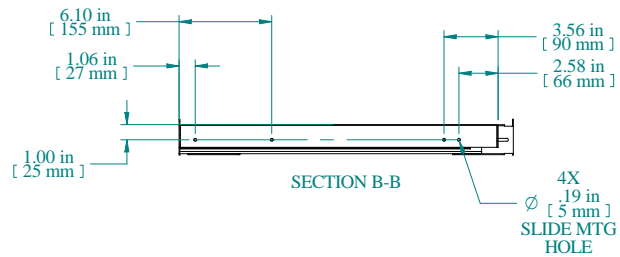

SECTION B-B

Item Number	Title	Quantity
1	RS - SOLID SHELF	1
2	SLIDE - 20" FULL TRAVEL	2
3	SLIDE MTG BRACKET	4

PART NUMBERS

RSUS1921BK1	PAINTED BLACK TEXTURED
RSUS1921CG1	PAINTED GREY/BEIGE TEXTURED

NOTES

Maximum Weight 120 lb
 Some Assembly Required
 Slide Assembly Hardware Omitted for Clarity

Data subject to change without notice. Isometric drawing not to scale.



**HAMMOND
MANUFACTURING™**
 www.hammondmfg.com
 PART NO. RSUS1921